



# YAMAHA



## 3A

## OWNER'S MANUAL

 Read this manual carefully before operating this outboard motor.

6L5-28199-25-E0

**Read this manual carefully before operating this outboard motor. Keep this manual onboard in a waterproof bag when boating. This manual should stay with the outboard motor if it is sold.**

# Important manual information

EMU25105

## To the owner

Thank you for choosing a Yamaha outboard motor. This Owner's Manual contains information needed for proper operation, maintenance and care. A thorough understanding of these simple instructions will help you obtain maximum enjoyment from your new Yamaha. If you have any question about the operation or maintenance of your outboard motor, please consult a Yamaha dealer.

In this Owner's Manual particularly important information is distinguished in the following ways.



: This is the safety alert symbol. It is used to alert you to potential personal injury hazards. Obey all safety messages that follow this symbol to avoid possible injury or death.

EWU00781



### **WARNING**

**A WARNING indicates a hazardous situation which, if not avoided, could result in death or serious injury.**

ECM00701

### **NOTICE**

**A NOTICE indicates special precautions that must be taken to avoid damage to the outboard motor or other property.**

### **TIP:**

A TIP provides key information to make procedures easier or clearer.

Yamaha continually seeks advancements in product design and quality. Therefore, while this manual contains the most current product information available at the time of printing, there may be minor discrepancies between

your machine and this manual. If there is any question concerning this manual, please consult your Yamaha dealer.

To ensure long product life, Yamaha recommends that you use the product and perform the specified periodic inspections and maintenance by correctly following the instructions in the owner's manual. Any damage resulting from neglect of these instructions is not covered by warranty.

Some countries have laws or regulations restricting users from taking the product out of the country where it was purchased, and it may be impossible to register the product in the destination country. Additionally, the warranty may not apply in certain regions. When planning to take the product to another country, consult the dealer where the product was purchased for further information.

If the product was purchased used, please consult your closest dealer for customer re-registration, and to be eligible for the specified services.

### **TIP:**

The 3AMH and the standard accessories are used as a base for the explanations and illustrations in this manual. Therefore some items may not apply to every model.

EMU25121

**3A  
OWNER'S MANUAL  
©2008 by Yamaha Motor Co., Ltd.  
1st Edition, February 2008  
All rights reserved.  
Any reprinting or unauthorized use  
without the written permission of  
Yamaha Motor Co., Ltd.  
is expressly prohibited.  
Printed in Japan**

# Table of contents

---

<b>Safety information.....</b>	<b>1</b>	Fuel tank cap.....	12
Outboard motor safety .....	1	Air vent screw .....	12
Propeller .....	1	Fuel cock .....	12
Rotating parts .....	1	Tiller handle .....	12
Hot parts .....	1	Gear shift lever .....	13
Electric shock .....	1	Throttle grip .....	13
Gasoline .....	1	Throttle indicator.....	13
Gasoline exposure and spills .....	1	Throttle friction adjuster.....	13
Carbon monoxide.....	1	Engine stop button .....	13
Modifications .....	1	Choke knob for pull type.....	14
Boating safety .....	1	Manual starter handle.....	14
Alcohol and drugs.....	1	Steering friction adjuster.....	14
Personal flotation devices .....	2	Trim rod (tilt pin) .....	14
People in the water.....	2	Tilt support bar .....	15
Passengers .....	2	Top cowling lock lever	
Overloading.....	2	(pull up type) .....	15
Avoid collisions.....	2	Carrying handle .....	15
Weather.....	3	<b>Installation .....</b>	<b>16</b>
Passenger training .....	3	Installation.....	16
Boating safety publications.....	3	Mounting the outboard motor .....	16
Laws and regulations .....	3	Clamping the outboard motor.....	17
<b>General information .....</b>	<b>4</b>	<b>Operation .....</b>	<b>19</b>
Identification numbers record .....	4	First-time operation .....	19
Outboard motor serial number .....	4	Breaking in engine.....	19
C-Tick label .....	4	Getting to know your boat .....	19
Read manuals and labels.....	5	Checks before starting engine .....	19
Warning labels.....	5	Fuel level .....	19
<b>Specifications and requirements.....</b>	<b>8</b>	Remove cowling .....	20
Specifications .....	8	Fuel system .....	20
Installation requirements .....	8	Controls .....	20
Boat horsepower rating .....	8	Oil .....	20
Mounting motor .....	9	Engine .....	20
Propeller selection.....	9	Install cowling .....	20
Engine oil requirements .....	9	Filling fuel and engine oil .....	21
Fuel requirements .....	9	Filling fuel for built-in tank.....	21
Gasoline .....	9	Gasoline and oil mixing (100:1).....	21
Muddy or acidic water .....	10	Operating engine .....	23
Anti-fouling paint .....	10	Feeding fuel.....	23
Motor disposal requirements.....	10	Starting engine .....	23
Emergency equipment .....	10	Checks after starting engine .....	25
<b>Components .....</b>	<b>11</b>	Cooling water .....	25
Components diagram .....	11	Warming up engine.....	25
Fuel tank.....	11	Choke start models .....	25

# Table of contents

---

Checks after engine warm-up .....	25	<b>Trouble Recovery.....</b>	<b>44</b>
Shifting .....	25	Troubleshooting .....	44
Stop switch .....	25	Temporary action in emergency ...	47
Shifting .....	25	Impact damage.....	47
Stopping engine .....	26	Starter will not operate .....	47
Procedure.....	26	Emergency starting engine.....	48
Trimming outboard motor.....	27	Treatment of submerged motor ....	48
Adjusting trim angle for manual tilt			
models .....	27		
Adjusting boat trim.....	28		
Tilting up and down .....	29		
Procedure for tilting up			
(manual tilt models).....	29		
Procedure for tilting down			
(manual tilt models).....	30		
Shallow water.....	30		
Cruising in shallow water			
(manual tilt models).....	30		
Cruising in other conditions.....	31		
<b>Maintenance.....</b>	<b>32</b>		
Transporting and storing outboard			
motor .....	32		
Clamp screw mounting models .....	32		
Storing outboard motor.....	32		
Procedure.....	33		
Lubrication.....	34		
Cleaning the outboard motor.....	34		
Checking painted surface of motor...	34		
Periodic maintenance.....	34		
Replacement parts .....	34		
Severe operating conditions.....	34		
Maintenance chart 1 .....	36		
Maintenance chart 2.....	37		
Greasing.....	38		
Cleaning and adjusting spark plug ...	39		
Inspecting idling speed.....	39		
Checking wiring and connectors .....	40		
Checking propeller .....	40		
Removing propeller .....	40		
Installing propeller .....	41		
Changing gear oil .....	41		
Inspecting and replacing anode(s) ...	42		

# Safety information

---

EMU33622

## Outboard motor safety

Observe these precautions at all times.

EMU336500

### Propeller

People can be injured or killed if they come in contact with the propeller. The propeller can keep moving even when the motor is in neutral, and sharp edges of the propeller can cut even when stationary.

- Shut off the engine when a person is in the water near you.
- Keep people out of reach of the propeller, even when the engine is off.

EMU33630

### Rotating parts

Hands, feet, hair, jewelry, clothing, PFD straps, etc. can become entangled with internal rotating parts of the engine, resulting in serious injury or death.

Keep the top cowling in place whenever possible. Do not remove or replace the cowling with the engine running.

Only operate the engine with the cowling removed according to the specific instructions in the manual. Keep hands, feet, hair, jewelry, clothing, PFD straps, etc. away from any exposed moving parts.

EMU33640

### Hot parts

During and after operation, engine parts are hot enough to cause burns. Avoid touching any parts under the top cowling until the engine has cooled.

EMU33650

### Electric shock

Do not touch any electrical parts while starting or operating the engine. They can cause shock or electrocution.

EMU33810

### Gasoline

**Gasoline and its vapors are highly flammable and explosive.** Always, refuel according to the procedure on page 23 to reduce the risk of fire and explosion.

EMU33820

### Gasoline exposure and spills

Take care not to spill gasoline. If gasoline spills, wipe it up immediately with dry rags. Dispose of rags properly.

If any gasoline spills onto your skin, immediately wash with soap and water. Change clothing if gasoline spills on it.

If you swallow gasoline, inhale a lot of gasoline vapor, or get gasoline in your eyes, get immediate medical attention. Never siphon fuel by mouth.

EMU33900

### Carbon monoxide

This product emits exhaust gases which contain carbon monoxide, a colorless, odorless gas which may cause brain damage or death when inhaled. Symptoms include nausea, dizziness, and drowsiness. Keep cockpit and cabin areas well ventilated. Avoid blocking exhaust outlets.

EMU33780

### Modifications

Do not attempt to modify this outboard motor. Modifications to your outboard motor may reduce safety and reliability, and render the outboard unsafe or illegal to use.

EMU33740

## Boating safety

This section includes a few of the many important safety precautions that you should follow when boating.

EMU33710

### Alcohol and drugs

Never operate after drinking alcohol or taking drugs. Intoxication is one of the most common factors contributing to boating fatalities.

EMU33720

## Personal flotation devices

Have an approved personal flotation device (PFD) on board for every occupant. Yamaha recommends that you must wear a PFD whenever boating. At a minimum, children and non-swimmers should always wear PFDs, and everyone should wear PFDs when there are potentially hazardous boating conditions.

EMU33730

## People in the water

Always watch carefully for people in the water, such as swimmers, skiers, or divers, whenever the engine is running. When someone is in the water near the boat, shift into neutral and shut off the motor.

Stay away from swimming areas. Swimmers can be hard to see.

The propeller can keep moving even when the motor is in neutral. Shut off the engine when a person is in the water near you.

EMU33750

## Passengers

Consult your boat manufacturer's instructions for details about appropriate passenger locations in your boat and be sure all passengers are positioned properly before accelerating and when operating above an idle speed. Standing or sitting in non-designated locations may result in being thrown either overboard or within the boat due to waves, wakes, or sudden changes in speed or direction. Even when people are positioned properly, alert your passengers if you must make any unusual maneuver. Always avoid jumping waves or wakes.

EMU33760

## Overloading

Do not overload the boat. Consult the boat capacity plate or boat manufacturer for maximum weight and number of passengers. Be sure that weight is properly distributed ac-

ording to the boat manufacturers instructions. Overloading or incorrect weight distribution can compromise the boats handling and lead to an accident, capsizing or swamping.

EMU33771

## Scan collisions

**Scan constantly** for people, objects, and other boats. Be alert for conditions that limit your visibility or block your vision of others.

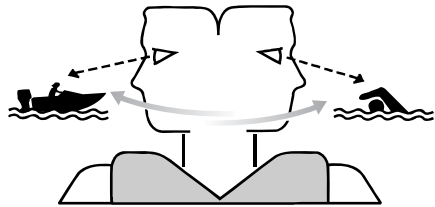

ZMU06025

**Operate defensively** at safe speeds and keep a safe distance away from people, objects, and other boats.

- Do not follow directly behind other boats or waterskiers.
- Avoid sharp turns or other maneuvers that make it hard for others to avoid you or understand where you are going.
- Avoid areas with submerged objects or shallow water.
- Ride within your limits and avoid aggressive maneuvers to reduce the risk of loss of control, ejection, and collision.
- **Take early action** to avoid collisions. Remember, **boats do not have brakes**, and stopping the engine or reducing throttle can reduce the ability to steer. If you are not sure that you can stop in time before hitting an obstacle, apply throttle and turn in another direction.

# Safety information

---

EMU33790

## **Weather**

Stay informed about the weather. Check weather forecasts before boating. Avoid boating in hazardous weather.

EMU33880

## **Passenger training**

Make sure at least one other passenger is trained to operate the boat in the event of an emergency.

EMU33890

## **Boating safety publications**

Be informed about boating safety. Additional publications and information can be obtained from many boating organizations.

EMU33600

## **Laws and regulations**

Know the marine laws and regulations where you will be boating- and obey them. Several sets of rules prevail according to geographic location, but all are basically the same as the International Rules of the Road.



EMU25171

## Identification numbers record

EMU25183

### Outboard motor serial number

The outboard motor serial number is stamped on the label attached to the port side of the clamp bracket.

Record your outboard motor serial number in the spaces provided to assist you in ordering spare parts from your Yamaha dealer or for reference in case your outboard motor is stolen.

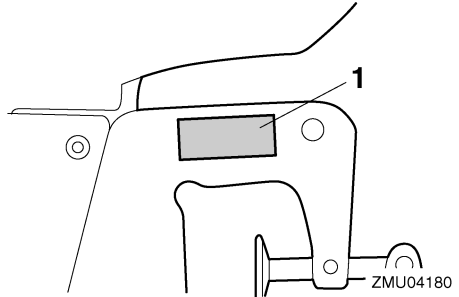

1. C-Tick label location

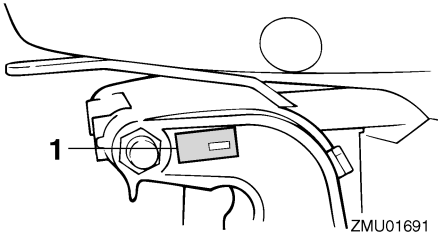

1. Outboard motor serial number location



ZMU01697

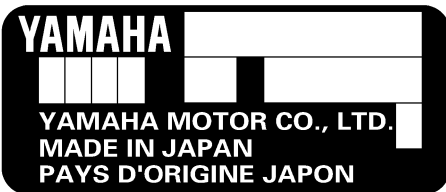

ZMU01692

EMU25213

### C-Tick label

Engines affixed with this label conform to certain portion(s) of the Australian Radio Communications Act.

# General information

---

EMU33520

## Read manuals and labels

Before operating or working on this motor:

- Read this manual.
  - Read any manuals supplied with the boat.
  - Read all labels on the outboard motor and the boat.
- If you need any additional information, contact your Yamaha dealer.

EMU33831

## Warning labels

If these labels are damaged or missing, contact your Yamaha dealer for replacements.

**3A**

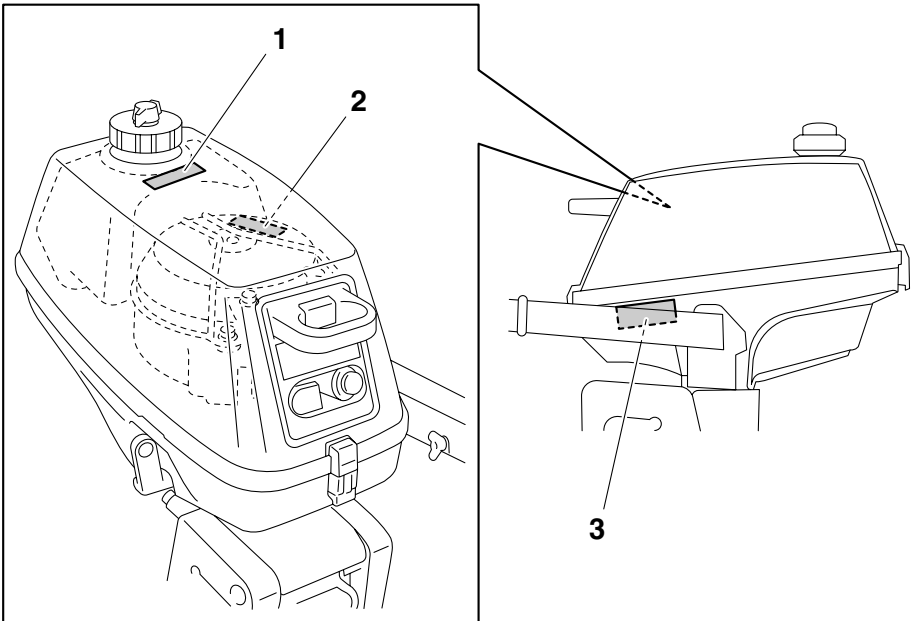

ZMU06032

1



2



3

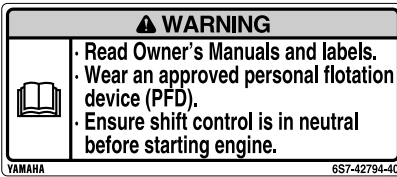

ZMU05810

EMU33922

## Contents of labels

The above warning labels mean as follows.

1

EWM01701

**⚠ WARNING**  
Gasoline is highly flammable and explosive. Shut off engine before refueling. Tighten tank cap and air vent screw when not in use.

2

EWM01681

**⚠ WARNING**  
● Keep hands, hair, and clothing away from rotating parts while the engine is running.  
● Do not touch or remove electrical parts when starting or during operation.

3

EWM01711

**⚠ WARNING**  
● Read Owner's Manuals and labels.  
● Wear an approved personal flotation device (PFD).  
● Ensure shift control is in neutral before starting engine.

# General information

---

EMU35132  
**Symbols**

The following symbols mean as follows.

### Electrical hazard

Notice/Warning



ZMU05696

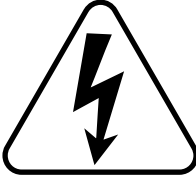

ZMU05666

Read Owner's Manual

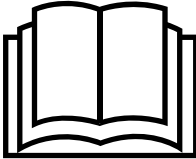

ZMU05664

Hazard caused by continuous rotation

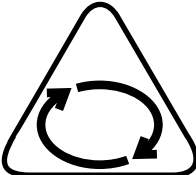

ZMU05665

# Specifications and requirements

EMU31480

## Specifications

### TIP:

“(AL)” stated in the specification data below represents the numerical value for the aluminum propeller installed.

Likewise, “(SUS)” represents the value for stainless steel propeller installed and “(PL)” for plastic propeller installed.

EMU2821C

### Dimension:

- Overall length:  
628 mm (24.7 in)
- Overall width:  
289 mm (11.4 in)
- Overall height S:  
997 mm (39.3 in)
- Transom height S:  
441 mm (17.4 in)
- Weight (AL) S:  
16.5 kg (36 lb)

### Performance:

- Full throttle operating range:  
4500–5500 r/min
- Maximum output:  
2.2 kW @ 5000 r/min (3 HP @ 5000 r/min)
- Idling speed (in neutral):  
1200 ±50 r/min

### Engine:

- Type:  
2-stroke S
- Displacement:  
70.0 cm<sup>3</sup>
- Bore × stroke:  
46.0 × 42.0 mm (1.81 × 1.65 in)
- Ignition system:  
CDI
- Spark plug (NGK):  
BR6HS-10
- Spark plug gap:  
0.9–1.0 mm (0.035–0.039 in)

- Control system:  
Tiller
- Starting system:  
Manual
- Starting carburetion system:  
Choke valve

### Drive unit:

- Gear positions:  
Forward-neutral
- Gear ratio:  
2.08 (27/13)
- Trim and tilt system:  
Manual tilt
- Propeller mark:  
BS

### Fuel and oil:

- Recommended fuel:  
Regular unleaded gasoline
- Fuel tank capacity (built in type):  
1.4 L (0.37 US gal, 0.31 Imp.gal)
- Recommended engine oil:  
YAMALUBE 2-stroke outboard motor oil
- Fuel:oil ratio:  
Regular gasoline:  
100 :1
- Lubrication:  
Pre-mixed fuel and oil
- Recommended gear oil:  
Hypoid gear oil SAE#90
- Gear oil quantity:  
0.075 L (0.079 US qt, 0.066 Imp.qt)

### Tightening torque for engine:

- Spark plug:  
25.0 Nm (2.55 kgf-m, 18.4 ft-lb)

EMU33553

## Installation requirements

EMU33563

### Boat horsepower rating

EWMO1560



**Overpowering a boat can cause severe instability.**

# Specifications and requirements

Before installing the outboard motor(s), confirm that the total horsepower of your motor(s) does not exceed the boat's maximum horsepower rating. See the boat's capacity plate or contact the manufacturer.

EMU33571

## Mounting motor

EWM01570

### WARNING

- **Improper mounting of the outboard motor could result in hazardous conditions such as poor handling, loss of control, or fire hazards.**
- **Because the motor is very heavy, special equipment and training is required to mount it safely.**

Your dealer or other person experienced in proper rigging should mount the motor using correct equipment and complete rigging instructions. For further information, see page 16.

EMU34191

## Propeller selection

Next to selecting an outboard, choosing the right propeller is one of the most important purchasing decisions a boater can make. The type, size, and design of your propeller have a direct impact on acceleration, top speed, fuel economy, and even engine life. Yamaha designs and manufactures propellers for every Yamaha outboard motor and every application.

Your outboard motor came with a Yamaha propeller chosen to perform well over a range of applications, but there may be uses where a different propeller would be more appropriate.

Your Yamaha dealer can help you select the right propeller for your boating needs. Select a propeller that will allow the engine to reach the middle or upper half of the operating range at full throttle with the maximum boat-

load. Generally, choose a larger pitch propeller for a smaller operating load and a smaller pitch propeller for a heavier load. If you carry loads that vary widely, choose the propeller that lets the engine run in the proper range for your maximum load but remember that you may need to reduce your throttle setting to stay within the recommended engine speed range when carrying lighter loads.

For instructions on propeller removal and installation, see page 40.

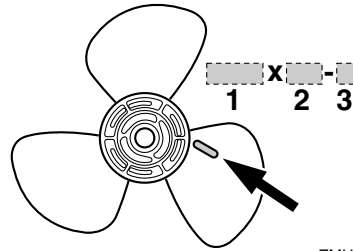

ZMU04604

1. Propeller diameter in inches
2. Propeller pitch in inches
3. Type of propeller (propeller mark)

EMU25651

## Engine oil requirements

Recommended engine oil:  
YAMALUBE 2-stroke outboard motor oil

If the recommended engine oil is not available, another 2-stroke engine oil with an NMMA-certified TC-W3 rating may be used.

EMU36360

## Fuel requirements

EMU36770

### Gasoline

Use a good quality gasoline that meets the minimum octane rating. If knocking or pinging occurs, use a different brand of gasoline or

# Specifications and requirements

premium unleaded fuel. Yamaha recommends that you use alcohol-free (see Gasohol) gasoline whenever possible.

Recommended gasoline:  
Regular unleaded gasoline

ECM01980

## NOTICE

- **Do not use leaded gasoline. Leaded gasoline can seriously damage the engine.**
- **Avoid getting water and contaminants in the fuel tank. Contaminated fuel can cause poor performance or engine damage. Use only fresh gasoline that has been stored in clean containers.**

## Gasohol

There are two types of gasohol: gasohol containing ethanol (E10) and that containing methanol. Ethanol can be used if the ethanol content does not exceed 10% and the fuel meets the minimum octane ratings. All ethanol blends containing more than 10% ethanol can cause fuel system damage or cause engine starting and running problems. Yamaha does not recommend gasohol containing methanol because it can cause fuel system damage or engine performance problems.

EMU36880

## Muddy or acidic water

Yamaha strongly recommends that you have your dealer install the optional chromium-plated water pump kit if you use the outboard motor in muddy or acidic water conditions. However, depending on the model it might not be required.

EMU36330

## Anti-fouling paint

A clean hull improves boat performance. The boat bottom should be kept as clean of marine growth as possible. If necessary, the boat bot-

tom can be coated with an anti-fouling paint approved for your area to inhibit marine growth.

Do not use anti-fouling paint which includes copper or graphite. These paints can cause more rapid engine corrosion.

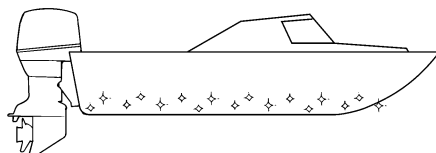

ZMU05176

EMU36341

## Motor disposal requirements

Never illegally discard (dump) the motor. Yamaha recommends consulting the dealer about discarding the motor.

EMU37460

## Emergency equipment

Keep the following items onboard in case there is trouble with the motor.

- A tool kit with assorted screwdrivers, pliers, wrenches (including metric sizes), and electrical tape.
- Waterproof flashlight with extra batteries.
- Spare parts, such as an extra set of spark plugs.

Consult your Yamaha dealer for details.

# Components

EMU2579J

## Components diagram

### TIP:

\* May not be exactly as shown; also may not be included as standard equipment on all models.

### 3A

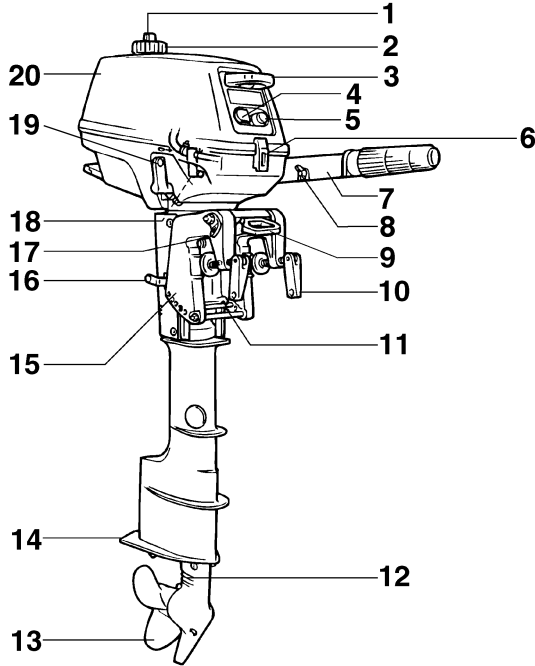

ZMU02426

1. Air vent screw
2. Fuel tank cap
3. Manual starter handle
4. Choke knob
5. Engine stop button
6. Top cowling lock lever

7. Tiller handle
8. Throttle friction adjuster
9. Carrying handle
10. Clamp screw
11. Trim rod
12. Cooling water inlet
13. Propeller
14. Anti-cavitation plate
15. Clamp bracket
16. Tilt support lever
17. Rope attachment
18. Fuel cock
19. Gear shift lever
20. Top cowling

EMU25821

### Fuel tank

If your model included a fuel tank, its parts and functions are as follows.



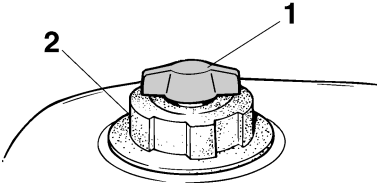

1. Air vent screw
2. Fuel tank cap

ZMU02427

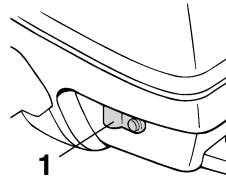

1. Close position

ZMU02428

EMU25850

## Fuel tank cap

This cap seals the fuel tank. When removed, the tank can be filled with fuel. To remove the cap, turn it counterclockwise.

EMU25860

## Air vent screw

This screw is on the fuel tank cap. To loosen the screw, turn it counterclockwise.

EMU25872

## Fuel cock

The fuel cock turns on and off the supply of fuel from the fuel tank to the engine.

EMU25891

## Open

With the lever/knob in this position, fuel flows to the carburetor.

Normal running is done with the lever/knob in this position.

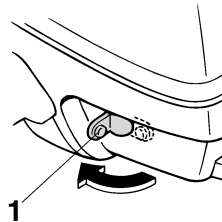

1. Open position

ZMU02429

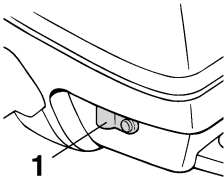

1. Fuel cock

ZMU02428

EMU25881

## Close

To stop fuel flow to the engine, turn the lever or knob to close position.

Always turn the lever or knob to close position when the engine is not running.

EMU25911

## Tiller handle

To change direction, move the tiller handle to the left or right as necessary.

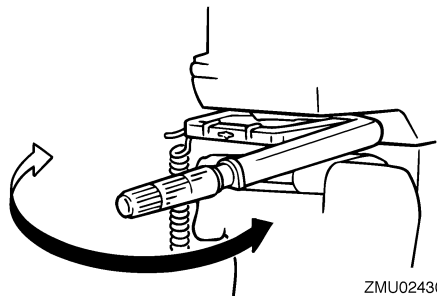

ZMU02430

# Components

EMU25930

## Gear shift lever

Pulling the gear shift lever towards you puts the engine in forward gear so that the boat moves ahead.

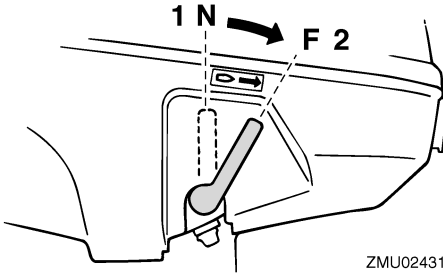

ZMU02431

1. Neutral "N"
2. Forward "F"

EMU25941

## Throttle grip

The throttle grip is on the tiller handle. Turn the grip counterclockwise to increase speed and clockwise to decrease speed.

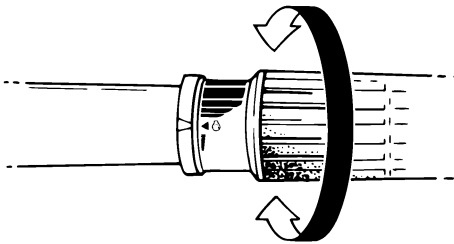

ZMU02432

EMU25961

## Throttle indicator

The fuel consumption curve on the throttle indicator shows the relative amount of fuel consumed for each throttle position. Choose the setting that offers the best performance and fuel economy for the desired operation.

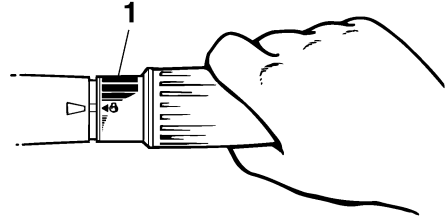

ZMU02433

1. Throttle indicator

EMU25973

## Throttle friction adjuster

A friction device provides adjustable resistance to movement of the throttle grip or the remote control lever, and can be set according to operator preference.

To increase resistance, turn the adjuster clockwise. **WARNING! Do not overtighten the friction adjuster. If there is too much resistance, it could be difficult to move the remote control lever or throttle grip, which could result in an accident.** [EVM00032]

To decrease resistance, turn the adjuster counterclockwise.

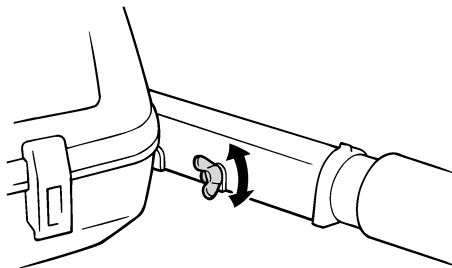

ZMU02434

When constant speed is desired, tighten the adjuster to maintain the desired throttle setting.

EMU26001

## Engine stop button

To open the ignition circuit and stop the engine, push this button.

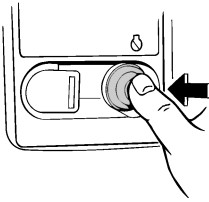

ZMU02435

EMU26011

## Choke knob for pull type

To supply the engine with the rich fuel mixture required to start, pull out this knob.

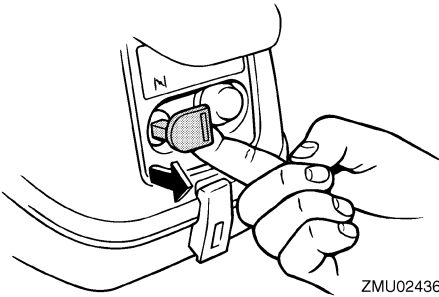

ZMU02436

EMU26070

## Manual starter handle

To start the engine, first gently pull the handle out until resistance is felt. From that position, then pull the handle straight out quickly to crank the engine.

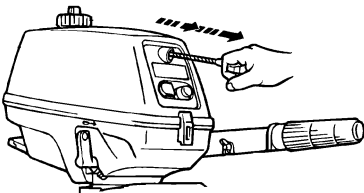

ZMU02437

EMU26122

## Steering friction adjuster

A friction device provides adjustable resistance to the steering mechanism, and can be set according to operator preference. An adjusting screw or bolt is located on the swivel bracket.

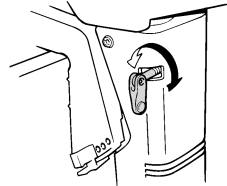

ZMU02438

To increase resistance, turn the adjuster clockwise.

To decrease resistance, turn the adjuster counterclockwise.

EWM00040

## **! WARNING**

**Do not overtighten the friction adjuster. If there is too much resistance, it could be difficult to steer, which could result in an accident.**

EMU26261

## Trim rod (tilt pin)

The position of the trim rod determines the minimum trim angle of the outboard motor in relation to the transom.

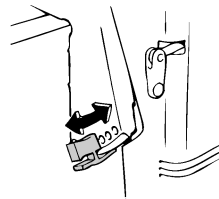

ZMU02439

# Components

---

EMU26332

## Tilt support bar

The tilt support bar keeps the outboard motor in the tilted up position.

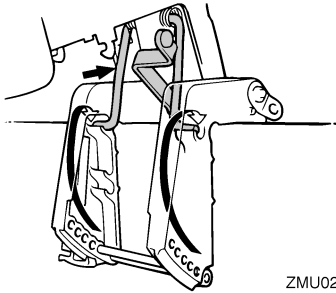

ZMU02440

EMU26450

## Carrying handle

A carrying handle is provided on the rear of the outboard motor. It enables you to carry the outboard motor easily with one hand.

ECM01660

## NOTICE

**Do not use the tilt support bar when trailering the boat. The outboard motor could shake loose from the tilt support and fall. If the motor cannot be trailered in the normal running position, use an additional support device to secure it in the tilt position.**

EMU26382

## Top cowling lock lever (pull up type)

To remove the engine top cowling, pull up the lock lever(s) and lift off the cowling. When installing the cowling, check to be sure it fits properly in the rubber seal. Then lock the cowling by moving the lever(s) downward.

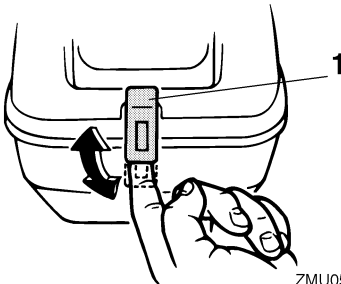

ZMU05345

1. Top cowling lock lever(s)

EMU26902

## Installation

The information presented in this section is intended as reference only. It is not possible to provide complete instructions for every possible boat and motor combination. Proper mounting depends in part on experience and the specific boat and motor combination.

EWM01590

### **WARNING**

- **Overpowering a boat could cause severe instability. Do not install an outboard motor with more horsepower than the maximum rating on the capacity plate of the boat. If the boat does not have a capacity plate, consult the boat manufacturer.**
- **Improper mounting of the outboard motor could result in hazardous conditions such as poor handling, loss of control, or fire hazards. For permanently mounted models, your dealer or other person experienced in proper rigging should mount the motor.**

EMU26911

## Mounting the outboard motor

EWM01720

### **WARNING**

Your dealer or other person experienced in proper outboard motor mounting should show you how to mount your outboard motor.

The outboard motor should be mounted so that the boat is well balanced. Otherwise, the boat could be hard to steer. For single-engine boats, mount the outboard motor on the centerline (keel line) of the boat.

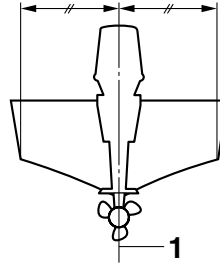

ZMU01760

1. Center line (keel line)

EMU26921

## Mounting height

To run your boat at optimum efficiency, the water resistance (drag) of the boat and outboard motor must be made as little as possible. The mounting height of the outboard motor greatly affects the water resistance. If the mounting height is too high, cavitation tends to occur, thus reducing the propulsion; and if the propeller tips cut the air, the engine speed will rise abnormally and cause the engine to overheat. If the mounting height is too low, the water resistance will increase and thereby reduce engine efficiency. Mount the outboard motor so that the anti-cavitation plate is between the bottom of the boat and a level 25 mm (1 in.) below it.

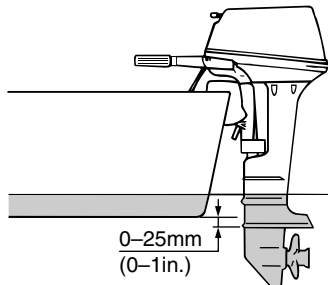

ZMU02011

# Installation

ECM01630

## NOTICE

- During water testing, check the buoyancy of the boat, at rest, with its maximum load. Check that the static water level on the exhaust housing is low enough to prevent water entry into the power head when water rises due to waves when the outboard is not running.
- Incorrect engine height or obstructions to the smooth flow of water (such as the design or condition of the boat, or accessories such as transom ladders or depth finder transducers) can create airborne water spray while the boat is cruising. If the motor is operated continuously in the presence of airborne water spray, enough water could enter the engine through the intake opening on the cowling to cause severe engine damage. Eliminate the cause of the airborne water spray.

## TIP:

- The optimum mounting height of the outboard motor is affected by the boat and motor combination and the desired use. Test runs at different heights can help determine the optimum mounting height. Consult your Yamaha dealer or boat manufacturer for further information on determining the proper mounting height.
- For instructions on setting the trim angle of the outboard motor, see page 27.

EMU26971

## Clamping the outboard motor

1. Place the outboard motor on the transom so that it is positioned as close to the center as possible. Tighten the transom clamp screws evenly and securely. Occasionally check the clamp screws for tightness during operation of the out-

board motor because they could become loose due to engine vibration. **WARNING! Loose clamp screws could allow the outboard motor to fall off or move on the transom. This could cause loss of control and serious injury. Make sure the transom screws are tightened securely. Occasionally check the screws for tightness during operation.** [EWM00641]

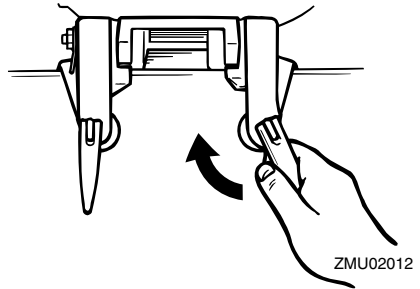

2. If the engine restraint cable attachment is equipped on your engine, an engine restraint cable or chain should be used. Attach one end to the engine restraint cable attachment and the other to a secure mounting point on the boat. Otherwise the engine could be completely lost if it accidentally falls off the transom.

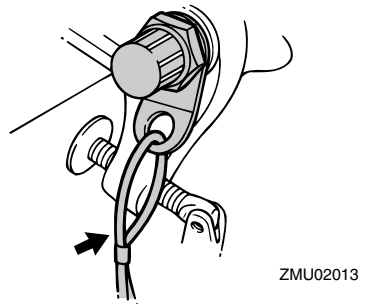

3. Secure the clamp bracket to the transom using the bolts provided with the outboard (if packed). For details, consult

your Yamaha dealer. **WARNING! Avoid using bolts, nuts or washers other than those contained in the engine packaging. If used, they must be of at least the same quality of material and strength and must be tightened securely. After tightening, test run the engine and check their tightness.**

[EWM00651]

# Operation

EMU36380

## First-time operation



EMU30174

### Breaking in engine



Your new engine requires a period of break-in to allow mating surfaces of moving parts to wear in evenly. Correct break-in will help ensure proper performance and longer engine life. **NOTICE: Failure to follow the break-in procedure could result in reduced engine life or even severe engine damage.** [ECM00801]

EMU27050

### Gasoline and engine oil mixing chart (25:1)

	25:1			
	1 L (0.26 US gal, 0.22 Imp gal)	12 L (3.2 US gal, 2.6 Imp gal)	14 L (3.7 US gal, 3.1 Imp gal)	24 L (6.3 US gal, 5.3 Imp gal)
	0.04 L (0.04 US qt, 0.04 Imp qt)	0.48 L (0.51 US qt, 0.42 Imp qt)	0.56 L (0.59 US qt, 0.49 Imp qt)	0.96 L (1.01 US qt, 0.84 Imp qt)

ZMU02393

1. : Gasoline
2. : Engine oil

ECM00150

### NOTICE

**Be sure to mix gasoline and oil completely, otherwise the engine may be damaged.**

EMU27074

### Procedure for pre-mixed models

Run the engine under load (in gear with a propeller installed) for 10 hours as follows.

1. First 10 minutes:  
Run the engine at the lowest possible speed. A fast idle in neutral is best.
2. Next 50 minutes:  
Do not exceed half throttle (approximately 3000 r/min). Vary engine speed occasionally. If you have an easy-planing boat, accelerate at full throttle onto plane, then immediately reduce the throttle to 3000 r/min or less.

3. Next two hours:  
Accelerate at full throttle onto plane, then reduce engine speed to three-quarter throttle (approximately 4000 r/min). Vary engine speed occasionally. Run at full throttle for one minute, then allow about 10 minutes of operation at three-quarter throttle or less to let the engine cool.
4. Remaining seven hours:  
Run the engine at any speed. However, avoid operating at full throttle for more than 5 minutes at a time.
5. After the first 10 hours:  
Operate the engine normally. Use the standard premix ratio of gasoline and oil. For details on mixing fuel and oil, see page 21.

EMU36400

### Getting to know your boat

Different boats handle differently. Operate cautiously while you learn how your boat handles under different conditions and with different trim angles (see page 27).

EMU36412

### Checks before starting engine

EWMO1920

### WARNING

**If any item in the checks before starting engine is not working properly, have it inspected and repaired before operating the outboard motor. Otherwise an accident could occur.**

ECM00120

### NOTICE

**Do not start the engine out of water. Overheating and serious engine damage can occur.**

EMU37141

### Fuel level

Be sure you have plenty of fuel for your trip. A good rule is to use 1/3 of your fuel to get to the destination, 1/3 to return, and to keep 1/3 as



an emergency reserve. With the boat level on a trailer or in the water, check the fuel level. For fuel filling instructions, see page 21.

EMU36431

## Remove cowling

For the following checks, remove the top cowling from the engine. To remove the engine cowling, release all the lock levers and lift off the cowling.

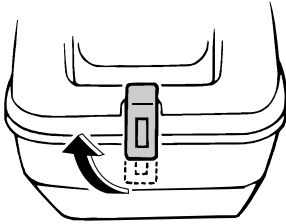

ZMU06104

EMU36442

## Fuel system

EWM00060



**Gasoline and its vapors are highly flammable and explosive. Keep away from sparks, cigarettes, flames, or other sources of ignition.**

EWM00910



**Leaking fuel can result in fire or explosion.**

- Check for fuel leakage regularly.
- If any fuel leakage is found, the fuel system must be repaired by a qualified mechanic. Improper repairs can make the outboard unsafe to operate.

EMU36450

## Check for fuel leaks

- Check under top cowling and in the boat for fuel leaks or gasoline fumes.
- Check fuel line connections to be sure they are tight.

- Check fuel lines for cracks, swelling, or other damage.

EMU36890

## Controls

- Turn the tiller handle fully to the left and right to make sure operation is smooth.
- Turn the throttle grip from the fully closed to the fully open position. Make sure that it turns smoothly and that it completely returns to the fully closed position.
- Look for loose or damaged connections of the throttle and shift cables under the engine cowling.

EMU27120

## Oil

- Check to be sure you have plenty of oil for your trip.

EMU27140

## Engine

- Check the engine and engine mounting.
- Look for loose or damaged fasteners.
- Check the propeller for damage.

EMU37550

## Install cowling

1. Be sure that all cowling lock levers are released.
2. Place the top cowling on the bottom cowling.
3. Check to be sure that the bottom cowling fits properly into the slot in the top cowling.
4. Move the levers to lock the cowling as shown. **NOTICE: If the cowling is not installed correctly, water spray under the cowling can damage the engine, or the cowling can blow off at high speeds.** [ECM01990]

# Operation

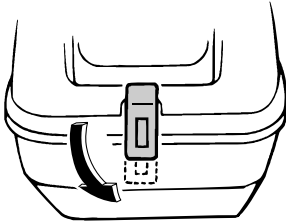

ZMU06129

After installing, check the fitting of the top cowling by pushing it with both hands. If the top cowling is loose, have it repaired by your Yamaha dealer.

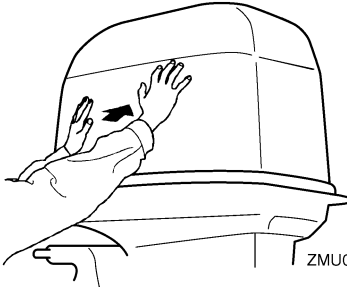

ZMU05175

EMU27234

## Filling fuel and engine oil

EMU37531

### Filling fuel for built-in tank

EWM01950

#### **WARNING**

**Be sure the outboard motor is securely fastened to the transom or a stable stand.**

EWM01830

#### **WARNING**

- Gasoline and its vapors are highly flammable and explosive. Always refuel according to this procedure to reduce the risk of fire and explosion.
- Gasoline is poisonous and can cause injury or death. Handle gasoline with care. Never siphon gasoline by mouth. If you

should swallow some gasoline or inhale a lot of gasoline vapor, or get some gasoline in your eyes, see your doctor immediately. If gasoline spills on your skin, wash with soap and water. If gasoline spills on your clothing, change your clothes.

1. Stop the engine.
2. Remove the portable tank (if equipped) from the boat.
3. Be sure you are in a well-ventilated outdoor area, either securely moored or trailered.
4. Do not smoke and keep away from sparks, flames, static electric discharge, or other sources of ignition.
5. If you use a portable container to store and dispense fuel, only use a locally approved GASOLINE container.
6. Touch the fuel nozzle to the filler opening or funnel to help prevent electrostatic sparks.
7. Fill the fuel tank, but do not overfill. Fuel can expand and overflow if the temperature increases.

Fuel tank capacity:

1.4 L (0.37 US gal, 0.31 Imp.gal)

8. Tighten the filler cap securely.
9. Wipe up any spilled gasoline immediately with dry rags. Dispose rags properly. According to local laws or regulations.

EMU27406

### Gasoline and oil mixing (100:1)



ECM00811

#### **NOTICE**



- Avoid using any oil other than the specified type.
- Use a thoroughly blended fuel-oil mixture.

- If the mixture is not thoroughly mixed, or if the mixing ratio is incorrect, the following problems could occur.
- **Low oil ratio:** Lack of oil could cause major engine trouble, such as piston seizure.
- **High oil ratio:** Too much oil could cause fouled spark plugs, smoky exhaust, and heavy carbon deposits.

	Gasoline to engine oil ratio
Break-in period	See page 19
After break-in	100:1

	100:1			
	1 L (0.26 US gal, 0.22 Imp gal)	12 L (3.2 US gal, 2.6 Imp gal)	14 L (3.7 US gal, 3.1 Imp gal)	24 L (6.3 US gal, 5.3 Imp gal)
	0.01 L (0.01 US qt, 0.01 Imp qt)	0.12 L (0.13 US qt, 0.11 Imp qt)	0.14 L (0.15 US qt, 0.12 Imp qt)	0.24 L (0.25 US qt, 0.21 Imp qt)

ZMU04910

1. : Gasoline
2. : Engine oil

### If equipped with a portable fuel tank

1. Pour oil into the portable fuel tank, and then add gasoline.
2. Replace the fuel tank cap and close tightly.
3. Shake the fuel tank to mix the fuel thoroughly.
4. Make sure that the oil and gasoline are mixed.

### If equipped with a built-in fuel tank

1. Pour oil into a clean fuel can, and then add gasoline.

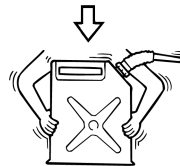
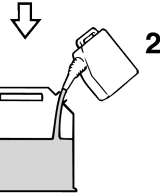
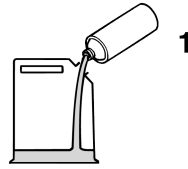

ZMU02886

1. Engine oil
2. Gasoline
2. Replace the fuel can cap and close tightly.
3. Shake the fuel can to mix the fuel thoroughly.
4. Make sure that the oil and gasoline are mixed.
5. Pour the gasoline and oil mixture into the built-in fuel tank.

### **TIP:**

If using a permanently installed tank, pour the oil gradually as the gasoline is being added to the tank.

# Operation

---

EMU27451

## Operating engine

EMU31510

### Feeding fuel

EWM00420

#### **WARNING**

- Before starting the engine, make sure that the boat is tightly moored and that you can steer clear of any obstructions. Be sure there are no swimmers in the water near you.
- When the air vent screw is loosened, gasoline vapor will be released. Gasoline is highly flammable, and its vapors are flammable and explosive. Refrain from smoking, and keep away from open flames and sparks while loosening the air vent screw.
- This product emits exhaust gases which contain carbon monoxide, a colorless, odorless gas which could cause brain damage or death when inhaled. Symptoms include nausea, dizziness, and drowsiness. Keep cockpit and cabin areas well ventilated. Avoid blocking exhaust outlets.

1. Loosen the air vent screw on the fuel tank cap by one turn.

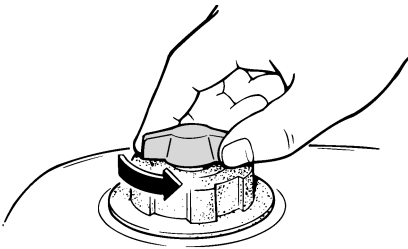

ZMU02443

2. Open the fuel cock.

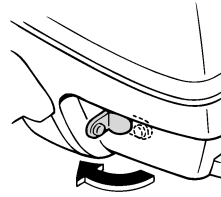

ZMU02444

EMU27492

## Starting engine

EWM01600

#### **WARNING**

Before starting the engine, make sure that the boat is tightly moored and that you can steer clear of any obstructions. Be sure there are no swimmers in the water near you.

EMU27525

## Manual start models

EWM01840

#### **WARNING**

- Failure to attached engine shut-off cord could result in a runaway boat if operator is ejected. Attach the engine shut-off cord to a secure place on your clothing, or your arm or leg while operating. Do not attach the cord to clothing that could tear loose. Do not route the cord where it could become entangled, preventing it from functioning.
- Avoid accidentally pulling the cord during normal operation. Loss of engine power means the loss of most steering control. Also, without engine power, the boat could slow rapidly. This could cause people and objects in the boat to be thrown forward.

1. Place the gear shift lever in neutral.  
**WARNING! Always start the engine in neutral to avoid accidentally moving the boat.** [EWM00111]

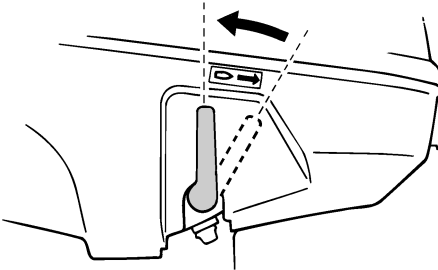

ZMU02445

2. If the engine shut-off cord is equipped, attach it to a secure place on your clothing, or your arm or leg. Then install the clip on the other end of the cord into the engine shut-off switch.
3. Place the throttle grip in the "START" (start) position.

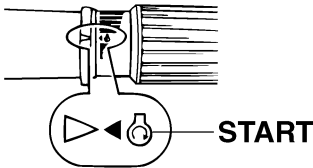

ZMU02446

4. Place the choke knob in the "START" (start) position. After the engine starts, return the knob to the "RUN" (run) position.

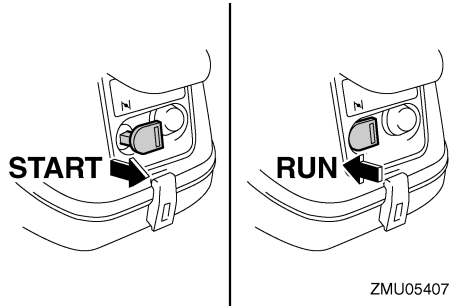

ZMU05407

## TIP:

- When restarting a warm engine, place the choke knob in the "RUN" (run) position.
  - If the choke knob is left in the "START" (start) position while the engine is running, the engine will run poorly or stall.
5. Pull the manual starter handle slowly until you feel resistance. Then give a strong pull straight out to start the engine. Repeat if necessary.

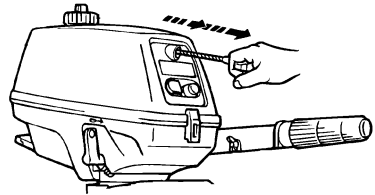

ZMU02437

6. After the engine starts, slowly return the manual starter handle to the original position before releasing it.
7. Slowly return the throttle grip to the fully closed position.

## TIP:

- When the engine is cold, it needs to be warmed up. For further information, see page 25.

# Operation

---

- If the engine does not start on the first try, repeat the procedure. If the engine fails to start after 4 or 5 tries, open the throttle a small amount (between 1/8 and 1/4) and try again. Also if the engine is warm and fails to start, open the throttle a same amount and try to start the engine again. If the engine still fails to start, see page 44.

EMU36510

## Checks after starting engine

EMU36520

### Cooling water

Check for a steady flow of water from the cooling water pilot hole. A continuous flow of water from the pilot hole shows that the water pump is pumping water through the cooling passages. If the cooling passages are frozen, it may take a while for water to start flowing out of the pilot hole.

ECM01810

### NOTICE

**If water is not flowing out of the pilot hole at all times while the engine is running, overheating and serious damage could occur. Stop the engine and check whether the cooling water inlet on the lower case or the cooling water pilot hole is blocked. Consult your Yamaha dealer if the problem cannot be located and corrected.**

---

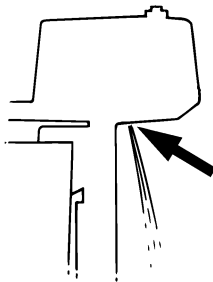

ZMU02447

Check that no water leaks from the joints between the exhaust cover, cylinder head, and body cylinder.

EMU27670

## Warming up engine

EMU27683

### Choke start models

After starting the engine, allow it to idle for 3 minutes to warm up. Failure to do so will shorten engine life. Gradually return the choke knob to its home position as the engine warms up.

EMU36530

## Checks after engine warm-up

EMU37540

### Shifting

While tightly moored, and without applying throttle, confirm that the engine shifts smoothly into forward and back to neutral.

EMU36990

### Stop switch

Press the engine stop button and make sure the engine stops.

EMU34890

## Shifting

EWM00180

### WARNING

**Before shifting, make sure there are no swimmers or obstacles in the water near you.**

---

ECM01610

### NOTICE

**Warm up the engine before shifting into gear. Until the engine is warm, the idle speed may be higher than normal. High idle speed can prevent you from shifting back to neutral. If this occurs, stop the engine, shift to neutral, then restart the engine and allow it to warm up.**

---

### To shift out of neutral (forward)

Move the gear shift lever firmly and crisply toward the bow.

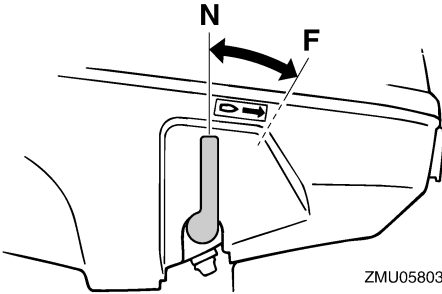

ZMU05803

### To shift out of neutral (reverse)

1. Turn the outboard motor around 180°, and then move the tiller handle so that it is facing toward the bow.

### **TIP:**

The outboard motor can be turned a full 360° in its bracket (full-pivot system).

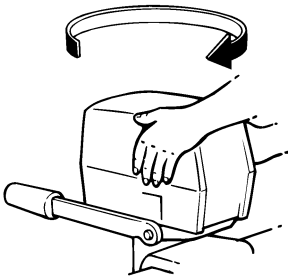

ZMU02165

2. Move the gear shift lever firmly and crisply toward the stern.

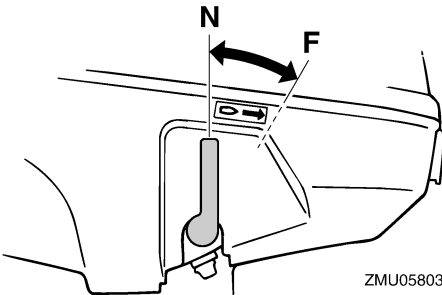

ZMU05803

### To shift from in gear to neutral

1. Close the throttle so that the engine slows to idle speed.

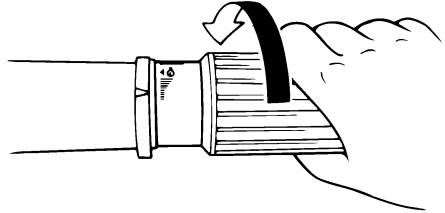

ZMU02448

2. After the engine is at idle speed in gear move the gear shift lever firmly and crisply into the neutral position.

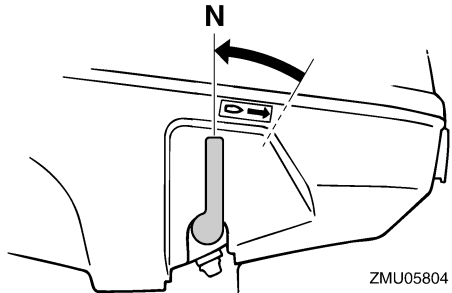

ZMU05804

EMU27821

## **Stopping engine**

Before stopping the engine, first let it cool off for a few minutes at idle or low speed. Stopping the engine immediately after operating at high speed is not recommended.

EMU34850

### **Procedure**

1. Push and hold the engine stop button until the engine comes to a complete stop.

# Operation

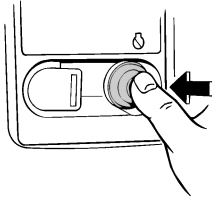

ZMU02435

2. After stopping the engine, tighten the air vent screw on the fuel tank cap and set the fuel cock to the closed position.



ZMU02450

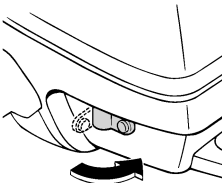

ZMU02451

EMU27862

## Trimming outboard motor

EWM00740



**WARNING**

**Excessive trim for the operating conditions (either trim up or trim down) can cause boat instability and can make steering the boat more difficult. This increases**

**the possibility of an accident. If the boat begins to feel unstable or is hard to steer, slow down and/or readjust the trim angle.**

The trim angle of the outboard motor helps determine the position of the bow of the boat in the water. Correct trim angle will help improve performance and fuel economy while reducing strain on the engine. Correct trim angle depends upon the combination of boat, engine, and propeller. Correct trim is also affected by variables such as the load in the boat, sea conditions, and running speed.

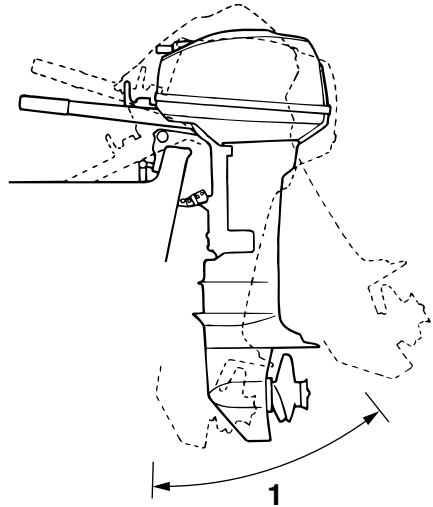

ZMU02043

1. Trim operating angle

EMU27872

## Adjusting trim angle for manual tilt models

There are 4 or 5 holes provided in the clamp bracket to adjust the outboard motor trim angle.

1. Stop the engine.
2. Tilt the outboard motor up, and then remove the trim rod from the clamp bracket.



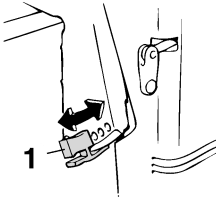

ZMU02453

1. Trim rod

3. Reposition the rod in the desired hole.

To raise the bow (“trim-out”), move the rod away from the transom.

To lower the bow (“trim-in”), move the rod toward the transom.

Make test runs with the trim set to different angles to find the position that works best for your boat and operating conditions.

EWM00400

## **WARNING**

- **Stop the engine before adjusting the trim angle.**
- **Use care to avoid being pinched when removing or installing the rod.**
- **Use caution when trying a trim position for the first time. Increase speed gradually and watch for any signs of instability or control problems. Improper trim angle can cause loss of control.**

## **TIP:**

The outboard motor trim angle can be changed approximately 4 degrees by shifting the trim rod one hole.

EMU27911

## **Adjusting boat trim**

When the boat is on plane, a bow-up attitude results in less drag, greater stability and efficiency. This is generally when the keel line of the boat is up about 3 to 5 degrees. With the bow up, the boat may have a greater tenden-

cy to steer to one side or the other. Compensate for this as you steer. The trim tab can also be adjusted to help offset this effect. When the bow of the boat is down, it is easier to accelerate from a standing start onto plane.

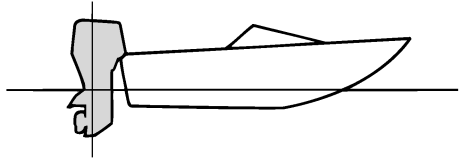

ZMU01784

## **Bow Up**

Too much trim-out puts the bow of the boat too high in the water. Performance and economy are decreased because the hull of the boat is pushing the water and there is more air drag. Excessive trim-out can also cause the propeller to ventilate, which reduces performance further, and the boat may “porpoise” (hop in the water), which could throw the operator and passengers overboard.

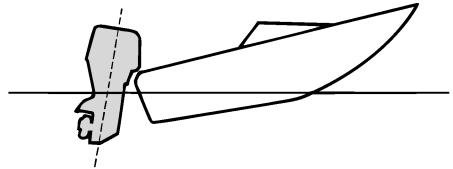

ZMU01785

## **Bow Down**

Too much trim-in causes the boat to “plow” through the water, decreasing fuel economy and making it hard to increase speed. Operating with excessive trim-in at higher speeds also makes the boat unstable. Resistance at

# Operation

the bow is greatly increased, heightening the danger of “bow steering” and making operation difficult and dangerous.

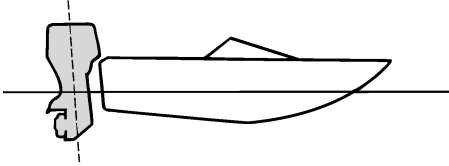

ZMU01786

## TIP:

Depending on the type of boat, the outboard motor trim angle may have little effect on the trim of the boat when operating.

EMU27922

## Tilting up and down

If the engine will be stopped for some time or if the boat is moored in shallows, the outboard motor should be tilted up to protect the propeller and lower casing from damage by collision with obstructions, and also to reduce salt corrosion.

EWM00221

### **WARNING**

Be sure all people are clear of the outboard motor when tilting up and down, Body parts can be crushed between the motor and the clamp bracket when the motor is trimmed or tilted.

EWM00230

### **WARNING**

Leaking fuel is a fire hazard. Tighten the air vent screw and place the fuel cock in the closed position if the outboard motor will be tilted for more than a few minutes. Otherwise fuel may leak.

ECM00231

### **NOTICE**

- Before tilting the outboard motor, follow the procedure under “Stopping engine” in this chapter. Never tilt the outboard motor while the engine is running. Severe damage from overheating can result.
- Do not tilt up the engine by pushing the tiller handle because this could break the handle.
- Keep the power unit higher than the propeller at all times. Otherwise water could run into the cylinder and cause damage.
- The outboard motor cannot be tilted when in reverse or when the outboard motor is turned 180° (facing the rear).

EMU34620

## Procedure for tilting up (manual tilt models)

1. Place the gear shift lever in neutral and face the outboard motor forward.
2. Tighten the steering friction adjuster by turning it clockwise to prevent the motor from turning freely.
3. Tighten the air vent screw.
4. Close the fuel cock.
5. Hold the rear of the top cowling or the rear handle (if equipped) with one hand and tilt the outboard motor up fully until the tilt support bar automatically locks.

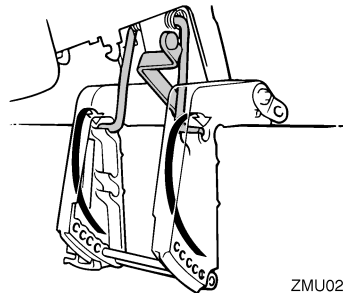

ZMU02454

ECM01670

## NOTICE

**Do not use the tilt support bar when trailering the boat. The outboard motor could shake loose from the tilt support and fall. If the motor cannot be trailered in the normal running position, use an additional support device to secure it in the tilt position. For more detailed information, see page 32.**

## TIP:

If the motor is not facing forward, the tilt support bar cannot automatically turn to the locked position. If the tilt support bar does not automatically lock, swing the motor a little to the left and right.

EMU28033

## Procedure for tilting down (manual tilt models)

1. Slightly tilt the outboard motor up.
2. If equipped with the tilt support bar: Slowly tilt the outboard motor down while pulling the tilt support bar lever up.

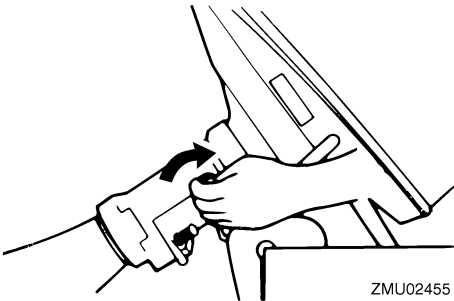

3. If equipped with the tilt support knob: Pull the knob out, and then slowly tilt the outboard motor down.
4. If equipped with the tilt support lever: Slowly tilt the outboard motor down while pulling the tilt support lever up.

5. Loosen the steering friction adjuster by turning it counterclockwise, and adjust the steering friction according to operator preference. **WARNING! If there is too much resistance it could be difficult to steer, which could result in an accident.** [EWM00721]

EMU28061

## Shallow water

EMU28073

## Cruising in shallow water (manual tilt models)

EWM01781

## WARNING

- Run the boat at the lowest possible speed when using the shallow water cruising system. The tilt lock mechanism does not work while the shallow water cruising system is being used. Hitting an underwater obstacle could cause the outboard motor to lift out of the water, resulting in loss of control.
- Use extra care when operating in reverse. Too much reverse thrust can cause the outboard motor to lift out of the water, increasing the chance of accident and personal injury.

ECM00260

## NOTICE

**Do not tilt the outboard motor up so that the cooling water inlet on the lower unit is above the surface of the water when setting up for and cruising in shallow water. Otherwise severe damage from overheating can result.**

# Operation

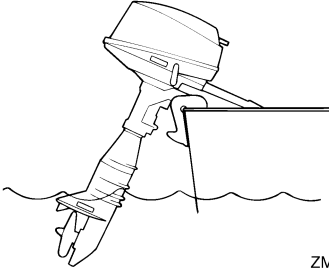

ZMU02456

EMU28102

## Procedure

1. Place the gear shift lever in neutral and face the outboard motor forward.

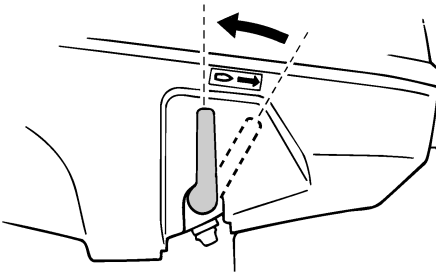

ZMU02445

2. Slightly tilt the outboard motor up until the tilt support bar automatically turns to the lock position to support the engine. The outboard motor is equipped with 2 or 3 positions for shallow water cruising.

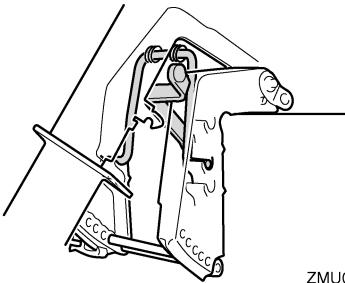

ZMU04455

3. To lower the outboard motor to the normal running position, first slightly tilt the outboard motor up. Then pull up the tilt support bar lever and slowly tilt the engine down.

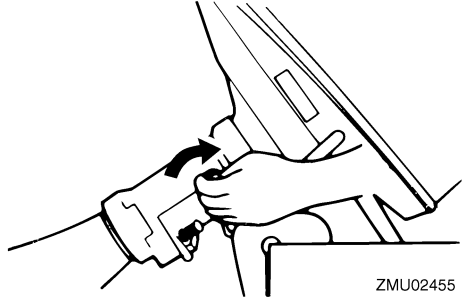

ZMU02455

EMU28194

## Cruising in other conditions

### Cruising in salt water

After operating in salt water, flush the cooling water passages with fresh water to prevent them from becoming clogged. Also rinse the outside of the outboard motor with fresh water and, if possible, rinse the power head under the cowling.

### Cruising in muddy, turbid, or acidic water

Yamaha strongly recommends that you use the optional chromium-plated water pump kit (see page 10) if you use the outboard motor in acidic water or water with a lot of sediment in it, such as muddy or turbid (cloudy) water. After operating in such water, flush the cooling passages with fresh water to prevent corrosion. Also rinse the outside of the outboard motor with fresh water.

EMU28226

## Transporting and storing outboard motor

EWM00692

### WARNING

- **USE CARE** when transporting fuel tank, whether in a boat or car.
- **DO NOT** fill fuel container to maximum capacity. Gasoline will expand considerably as it warms up and can build up pressure in the fuel container. This can cause fuel leakage and a potential fire hazard.

EWM01860

### WARNING

Leaking fuel is a fire hazard. When transporting and storing the outboard motor, close the fuel cock to prevent fuel from leaking. Never get under the engine while it is tilted. Severe injury could occur if the outboard motor accidentally falls.

ECM00660

### NOTICE

Do not use the tilt support lever or knob when trailering the boat. The outboard motor could shake loose from the tilt support and fall. If the motor cannot be trailered in the normal running position, use an additional support device to secure it in the tilt position.

The outboard motor should be trailered and stored in the normal running position. If there is insufficient road clearance in this position, then trailer the outboard motor in the tilt position using a motor support device such as a transom saver bar. Consult your Yamaha dealer for further details.

EMU28235

## Clamp screw mounting models

When transporting or storing the outboard motor while removed from a boat, keep the outboard motor in the attitude shown.

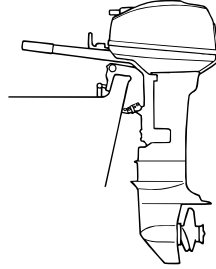

ZMU02870

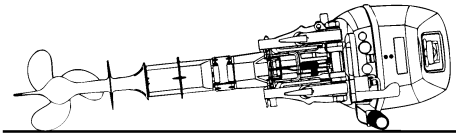

ZMU02458

### TIP:

Place a towel or something similar under the outboard motor to protect it from damage.

EMU30272

## Storing outboard motor

When storing your Yamaha outboard motor for prolonged periods of time (2 months or longer), several important procedures must be performed to prevent excessive damage. It is advisable to have your outboard motor serviced by an authorized Yamaha dealer prior to storage. However, you, the owner, with a minimum of tools, can perform the following procedures.

# Maintenance

ECM01411

## NOTICE

- Do not place the outboard motor on its side before the cooling water has drained from it completely, otherwise water may enter the cylinder through the exhaust port and cause engine trouble.
- Store the outboard motor in a dry, well-ventilated place, not in direct sunlight.

EMU28303

## Procedure

EMU28315

### Flushing in a water tank

1. Wash the outboard motor body using fresh water. **NOTICE: Do not spray water into the air intake.** [ECM01840] For further information, see page 34.
2. Place the fuel cock in the closed position and disconnect the fuel line if equipped. Tighten the air vent screw, if equipped.
3. Remove the engine top cowling and silencer cover.
4. Install the outboard motor on the test tank.

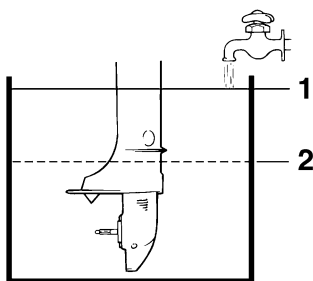

ZMU02176

1. Water surface
  2. Lowest water level
5. Fill the tank with fresh water to above the level of the anti-cavitation plate. **NOTICE: If the fresh water level is below the level of the anti-cavitation plate, or if the water supply is insufficient, engine seizure may occur.** [ECM00291]

6. Cooling system flushing is essential to prevent the cooling system from clogging up with salt, sand, or dirt. In addition, fogging/lubricating of the engine is mandatory to prevent excessive engine damage due to rust. Perform the flushing and fogging at the same time. **WARNING! Do not touch or remove electrical parts when starting or during operation. Keep hands, hair, and clothes away from the flywheel and other rotating parts while the engine is running.**

[EWM00091]

7. Run the engine at a fast idle for a few minutes in neutral position.
8. Just prior to turning off the engine, quickly spray "Fogging Oil" alternately into each carburetor or the fogging hole of the silencer cover, if equipped. When properly done, the engine will smoke excessively and almost stall.
9. If "Fogging Oil" is not available, run the engine at a fast idle until the fuel system empties and the engine stops.
10. Remove the outboard motor from the test tank.
11. Install the silencer cover or fogging hole cap, and the top cowling.
12. Drain the cooling water completely out of the motor. Clean the body thoroughly.
13. If "Fogging Oil" is not available, remove the spark plug(s). Pour a teaspoonful of clean engine oil into each cylinder. Crank several times manually. Replace the spark plug(s).
14. Drain the fuel from both the built-in and portable fuel tanks, on equipped models.

### TIP:

Portable fuel tank equipped models: Store the portable fuel tank in a dry, well-ventilated place, not in direct sunlight.

EMU28402

## Lubrication

1. Install the spark plug(s) and torque to proper specification. For information on spark plug installation, see page 39.
2. Change the gear oil. For instructions, see page 41. Inspect the oil for the presence of water that indicates a leaky seal. Seal replacement should be performed by an authorized Yamaha dealer prior to use.
3. Grease all grease fittings. For further details, see page 38.

### TIP:

For long-term storage, fogging the engine with oil is recommended. Contact your Yamaha dealer for information about fogging oil and procedures for your engine.

EMU28450

## Cleaning the outboard motor

After use, wash the exterior of the outboard motor with fresh water. Flush the cooling system with fresh water.

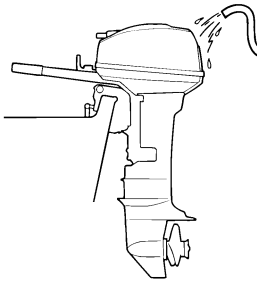

ZMU02459

### TIP:

For cooling system flushing instructions, see page 32.

EMU28460

## Checking painted surface of motor

Check the motor for scratches, nicks, or flaking paint. Areas with damaged paint are more likely to corrode. If necessary, clean and paint the areas. A touch-up paint is available from your Yamaha dealer.

EMU37101

## Periodic maintenance

EWM01990

### WARNING

**These procedures require mechanical skills, tools, and supplies. If you do not have the proper skills, tools, or supplies to perform a maintenance procedure, have a Yamaha dealer or other qualified mechanic do the work.**

**The procedures involve disassembling the motor and exposing dangerous parts. To reduce the risk of injury from moving, hot, or electrical parts:**

- Turn off the engine when you perform maintenance unless otherwise specified.
- Allow the engine to cool before handling hot parts or fluids.
- Always completely reassemble the motor before operation.

EMU28511

## Replacement parts

If replacement parts are necessary, use only genuine Yamaha parts or parts of equivalent design and quality. Any part of inferior quality may malfunction, and the resulting loss of control could endanger the operator and passengers. Yamaha genuine parts and accessories are available from your Yamaha dealer.

EMU34150

## Severe operating conditions

Severe operating conditions involve one or more of the following types of operation on a regular basis:

- Operating continuously at or near maximum engine speed (rpm) for many hours
- Operating continuously at a low engine speed (rpm) for many hours

# Maintenance

---

- Brief periods of rapid acceleration and deceleration followed by engine shut off before the engine has reached proper operating temperature
- Frequent quick acceleration and deceleration
- Frequent shifting
- Frequently starting and stopping the engine(s)
- Operation that fluctuates often between light and heavy cargo loads

Outboard motors operating under any of these above conditions require more frequent maintenance. Yamaha recommends that you do this service twice as often as specified in the maintenance chart. For example, if a particular service should be done at 50 hours, do it instead at 25 hours. This will help prevent more rapid deterioration of engine components.



EMU34445

## Maintenance chart 1

### TIP:

- Refer to the sections in this chapter for explanations of each owner-specific action.
- The maintenance cycle on these charts assume usage of 100 hours per year and regular flushing of the cooling water passages. Maintenance frequency should be adjusted when operating the engine under adverse conditions such as extended trolling.
- Disassembly or repairs may be necessary depending on the outcome of maintenance checks.
- Expendable or consumable parts and lubricants will lose their effectiveness over time and through normal usage regardless of the warranty period.
- When operating in salt water, muddy, other turbid (cloudy), acidic water, the engine should be flushed with clean water after each use.

The “●” symbol indicates the check-ups which you may carry out yourself.

The “○” symbol indicates work to be carried out by your Yamaha dealer.

Item	Actions	Initial	Every			
		20 hours (3 months)	100 hours (1 year)	300 hours (3 years)	500 hours (5 years)	
Anode(s) (external)	Inspection or replacement as necessary		●/○			
Cooling water leakage	Inspection or replacement as necessary	○	○			
Cowling clamp	Inspection		●/○			
Engine starting condition/Noise	Inspection	●/○	●/○			
Engine idling speed/Noise	Inspection	●/○	●/○			
Fuel filter (inside built-in fuel tank)	Inspection and cleaning as necessary		○			
Fuel line(High pressure)	Inspection	●	●			
Fuel line(High pressure)	Inspection or replacement as necessary	○	○			
Fuel line(Low pressure)	Inspection	●	●			
Fuel line(Low pressure)	Inspection or replacement as necessary	○	○			
Fuel pump	Inspection or replacement as necessary			○		
Fuel/oil leakage	Inspection	○	○			
Gear oil	Replacement	●/○	●/○			
Greasing points	Greasing	●/○	●/○			

# Maintenance

Item	Actions	Initial	Every			
		20 hours (3 months)	100 hours (1 year)	300 hours (3 years)	500 hours (5 years)	
Impeller/water pump housing	Inspection or replacement as necessary		○			
Impeller/water pump housing	Replacement			○		
Propeller/Propeller nut/Cotter pin	Inspection or replacement as necessary	●/○	●/○			
Shift link/shift cable	Inspection, adjustment or replacement as necessary	○	○			
Spark plug(s)	Inspection or replacement as necessary		●/○			
Spark plug caps/high tension cords	Inspection or replacement as necessary	○	○			
Water from the cooling water pilot hole	Inspection	●/○	●/○			
Throttle link/Throttle cable/Throttle pick-up timing	Inspection, adjustment or replacement as necessary	○	○			
Thermostat	Inspection or replacement as necessary		○			
Water inlet	Inspection	●/○	●/○			
Main switch/stop switch/choke switch	Inspection or replacement as necessary	○	○			
Wire harness connections/Wire coupler connections	Inspection or replacement as necessary	○	○			
Fuel tank (built-in tank)	Inspection and cleaning as necessary		○			

EMU34451

## Maintenance chart 2

Item	Actions	Every
		1000 hours
Guide exhaust/exhaust manifold	Inspection or replacement as necessary	○

EMU28941

## Greasing

Yamaha grease A (water resistant grease)

Yamaha grease D (corrosion resistant grease; for propeller shaft)

### 3A

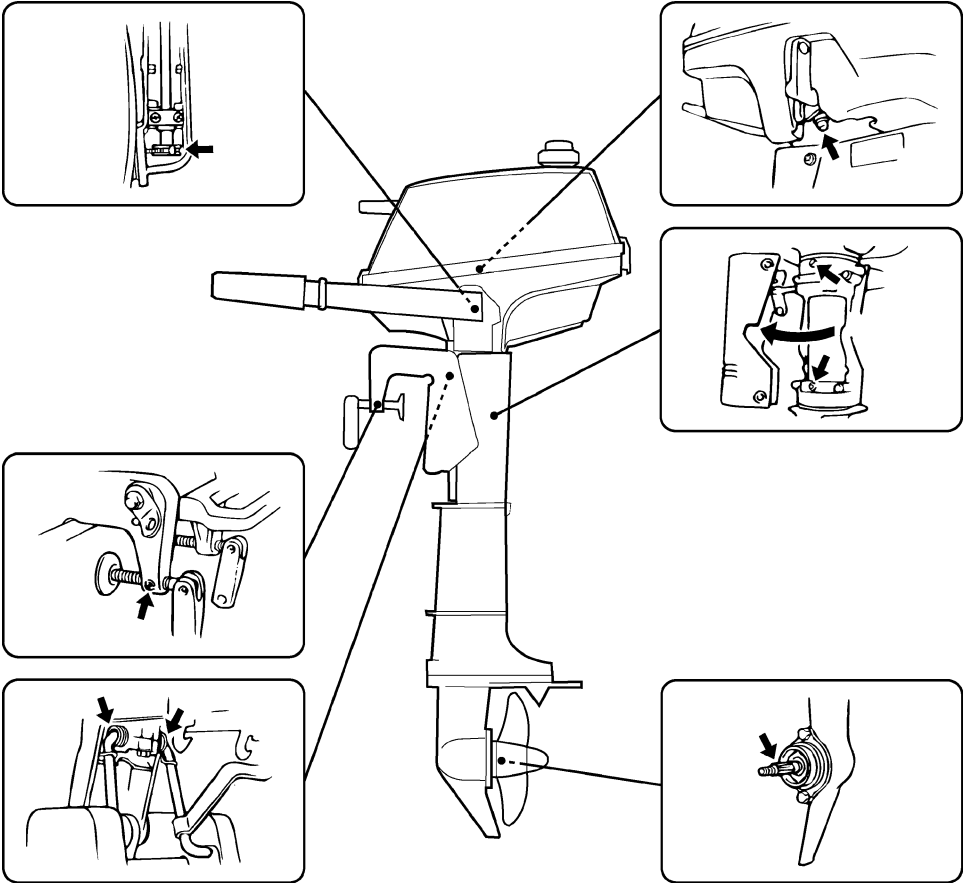

ZMU02460

# Maintenance

EMU28955

## Cleaning and adjusting spark plug

The spark plug is an important engine component and is easy to inspect. The condition of the spark plug can indicate something about the condition of the engine. For example, if the center electrode porcelain is very white, this could indicate an intake air leak or carburetion problem in that cylinder. Do not attempt to diagnose any problems yourself. Instead, take the outboard motor to a Yamaha dealer. You should periodically remove and inspect the spark plug because heat and deposits will cause the spark plug to slowly break down and erode. If electrode erosion becomes excessive, or if carbon and other deposits are excessive, you should replace the spark plug with another of the correct type.

1. Remove the spark plug caps from the spark plugs.
2. Remove the spark plug. If electrode erosion becomes excessive, or if carbon and other deposits are excessive, you should replace the spark plug with another of the correct type. **WARNING! When removing or installing a spark plug, be careful not to damage the insulator. A damaged insulator could allow external sparks, which could lead to explosion or fire.** [EWM00561]

Standard spark plug:  
BR6HS-10

3. Be sure to use the specified spark plug, otherwise the engine may not operate properly. Before fitting the spark plug, measure the electrode gap with a wire thickness gauge; adjust the gap to specification if necessary.

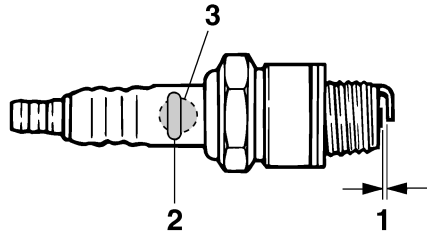

ZMU02179

1. Spark plug gap
2. Spark plug part number
3. Spark plug I.D. mark (NGK)

Spark plug gap:  
0.9–1.0 mm (0.035–0.039 in)

4. When fitting the plug, wipe off any dirt from the threads, and then screw it in to the correct torque.

Spark plug torque:  
25.0 Nm (2.55 kgf-m, 18.4 ft-lb)

### TIP:

If a torque-wrench is not available when you are fitting a spark plug, a good estimate of the correct torque is 1/4 to 1/2 a turn past finger-tight. Have the spark plug adjusted to the correct torque as soon as possible with a torque-wrench.

EMU29041

## Inspecting idling speed

EWM00451

### WARNING

- Do not touch or remove electrical parts when starting or during operation.
- Keep hands, hair, and clothes away from the flywheel and other rotating parts while the engine is running.

ECM00490

## NOTICE

**This procedure must be performed while the outboard motor is in the water. A flushing attachment or test tank can be used.**

A diagnostic tachometer should be used for this procedure. Results may vary depending on whether testing is conducted with the flushing attachment, in a test tank, or with the outboard motor in the water.

1. Start the engine and allow it to warm up fully in neutral until it is running smoothly.

## TIP:

Correct idling speed inspection is only possible if the engine is fully warmed up. If not warmed up fully, the idle speed will measure higher than normal. If you have difficulty verifying the idle speed, or the idle speed requires adjustment, consult a Yamaha dealer or other qualified mechanic.

2. Verify whether the idle speed is set to specification. For idle speed specifications, see page 8.

EMU29112

## Checking wiring and connectors

- Check that each grounding wire is properly secured.
- Check that each connector is engaged securely.

EMU34861

## Checking propeller

EWM01731

## WARNING

**You could be seriously injured if the engine accidentally starts when you are near the propeller. Before inspecting, removing, or installing the propeller, place the shift control in neutral.**

Do not use your hand to hold the propeller when loosening or tightening the propeller nut. Put a wood block between the anti-cavitation plate and the propeller to prevent the propeller from turning.

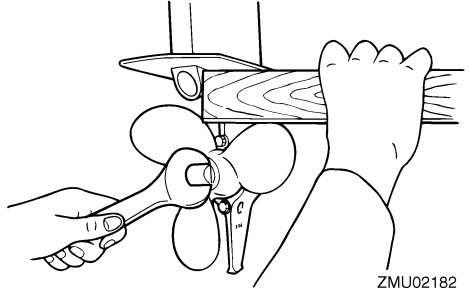

ZMU02182

## Checkpoints

- Check each of the propeller blades for wear, erosion from cavitation or ventilation, or other damage.
- Check the propeller shaft for damage.
- Check the splines for wear or damage.
- Check for fish line tangled around the propeller shaft.

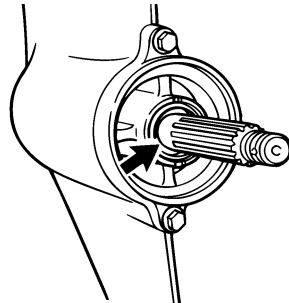

ZMU02274

- Check the propeller shaft oil seal for damage.

EMU30661

## Removing propeller

EMU29197

### Spline models

1. Straighten the cotter pin and pull it out using a pair of pliers.

# Maintenance

2. Remove the propeller nut, washer, and spacer (if equipped). **WARNING! Do not use your hand to hold the propeller when loosening the propeller nut.**

[EWM01890]

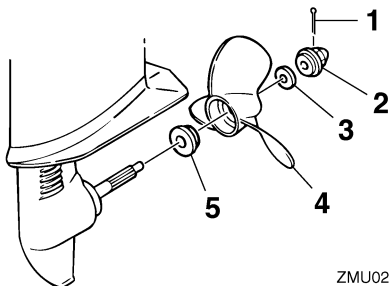

1. Cotter pin
2. Propeller nut
3. Washer
4. Propeller
5. Thrust washer

3. Remove the propeller, washer (if equipped), and thrust washer.

EMU30671

## Installing propeller

EMU30372

### Spline models

ECM00500

#### **NOTICE**

**Be sure to use a new cotter pin and bend the ends over securely. Otherwise the propeller could come off during operation and be lost.**

1. Apply Yamaha marine grease or a corrosion resistant grease to the propeller shaft.
2. Install the spacer (if equipped), thrust washer, and propeller on the propeller shaft. **NOTICE: Be sure to install the thrust washer before installing the propeller, otherwise the lower case and propeller boss could be damaged.**

[ECM01880]

3. Install the spacer (if equipped) and the washer. Tighten the propeller nut until there is no forward-and-backward movement.
4. Align the propeller nut with the propeller shaft hole. Insert a new cotter pin in the hole and bend the cotter pin ends. **NOTICE: Do not reuse the cotter pin installed. Otherwise the propeller can come off during operation.** [ECM01890]

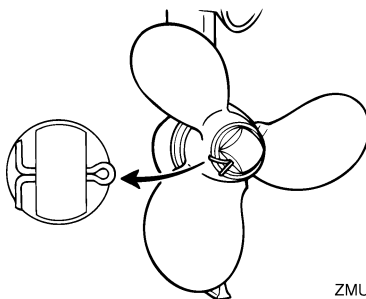

#### TIP:

If the propeller nut does not align with the propeller shaft hole after tightening it, loosen the nut until it aligns with the hole.

EMU29287

## Changing gear oil

EWM00800

#### **! WARNING**

- Be sure the outboard motor is securely fastened to the transom or a stable stand. You could be severely injured if the outboard motor falls on you.
- Never get under the lower unit while it is tilted, even when the tilt support lever or knob is locked. Severe injury could occur if the outboard motor accidentally falls.

1. Tilt the outboard motor so that the gear oil drain screw is at the lowest point possible.

- Place a suitable container under the gear case.
- Remove the gear oil drain screw and gasket. **NOTICE: If there is an excessive quantity of metal particles on the magnetic gear oil drain screw, this can indicate lower unit problem. Consult your Yamaha dealer.** [ECM01900]

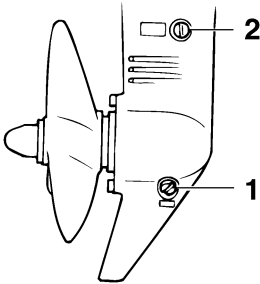

ZMU02463

- Gear oil drain screw
- Oil level plug

### TIP:

- If a magnetic gear oil drain screw is equipped, remove all metal particles from the screw before installing it.
- Always use new gaskets. Do not reuse the removed gaskets.

- Remove the oil level plug and gasket to allow the oil to drain completely. **NOTICE: Inspect the used oil after it has been drained. If the oil is milky, water is getting into the gear case which can cause gear damage. Consult a Yamaha dealer for repair of the lower unit seals.** [ECM00711]

### TIP:

For disposal of used oil, consult your Yamaha dealer.

- Put the outboard motor in a vertical position. Using a flexible or pressurized filling device, inject the gear oil into the gear oil drain screw hole.

Recommended gear oil:  
Hypoid gear oil SAE#90  
Gear oil quantity:  
0.075 L (0.079 US qt, 0.066 Imp.qt)

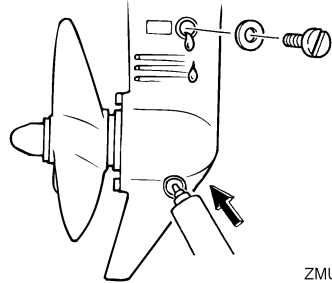

ZMU02464

- Put a new gasket on the oil level plug. When the oil begins to flow out of the oil level plug hole, insert and tighten the oil level plug.

Tightening torque:  
9.0 Nm (0.92 kgf-m, 6.6 ft-lb)

- Put a new gasket on the gear oil drain screw. Insert and tighten the gear oil drain screw.

Tightening torque:  
9.0 Nm (0.92 kgf-m, 6.6 ft-lb)

EMU29312

### Inspecting and replacing anode(s)

Yamaha outboard motors are protected from corrosion by sacrificial anodes. Inspect the external anodes periodically. Remove scales from the surfaces of the anodes. Consult a Yamaha dealer for replacement of external anodes.

ECM00720

### NOTICE

**Do not paint anodes, as this would render them ineffective.**

# Maintenance

---

**TIP:**

Inspect ground leads attached to external anodes on equipped models. Consult a Yamaha dealer for inspection and replacement of internal anodes attached to the power unit.

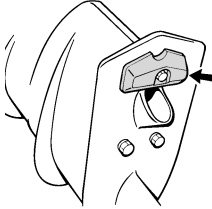

ZMU02465



EMU29427

## Troubleshooting

A problem in the fuel, compression, or ignition systems can cause poor starting, loss of power, or other problems. This section describes basic checks and possible remedies, and covers all Yamaha outboard motors. Therefore some items may not apply to your model.

If your outboard motor requires repair, bring it to your Yamaha dealer.

If the engine trouble-alert indicator is flashing, consult your Yamaha dealer.

### **Starter will not operate.**

Q. Is battery capacity weak or low?

A. Check battery condition. Use battery of recommended capacity.

Q. Are battery connections loose or corroded?

A. Tighten battery cables and clean battery terminals.

Q. Is fuse for electric start relay or electric circuit blown?

A. Check for cause of electric overload and repair. Replace fuse with one of correct amperage.

Q. Are starter components faulty?

A. Have serviced by a Yamaha dealer.

Q. Is shift lever in gear?

A. Shift to neutral.

### **Engine will not start (starter operates).**

Q. Is fuel tank empty?

A. Fill tank with clean, fresh fuel.

Q. Is fuel contaminated or stale?

A. Fill tank with clean, fresh fuel.

Q. Is fuel filter clogged?

A. Clean or replace filter.

Q. Is starting procedure incorrect?

A. See page 23.

Q. Has fuel pump malfunctioned?

A. Have serviced by a Yamaha dealer.

Q. Are spark plug(s) fouled or of incorrect type?

A. Inspect spark plug(s). Clean or replace with recommended type.

Q. Are spark plug cap(s) fitted incorrectly?

A. Check and re-fit cap(s).

Q. Is ignition wiring damaged or poorly connected?

A. Check wires for wear or breaks. Tighten all loose connections. Replace worn or broken wires.

Q. Are ignition parts faulty?

A. Have serviced by a Yamaha dealer.

Q. Is engine shut-off cord (lanyard) not attached?

A. Attach cord.

Q. Are engine inner parts damaged?

A. Have serviced by a Yamaha dealer.

### **Engine idles irregularly or stalls.**

Q. Are spark plug(s) fouled or of incorrect type?

A. Inspect spark plug(s). Clean or replace with recommended type.

Q. Is fuel system obstructed?

# Trouble Recovery

---

A. Check for pinched or kinked fuel line or other obstructions in fuel system.

Q. Is fuel contaminated or stale?

A. Fill tank with clean, fresh fuel.

Q. Is fuel filter clogged?

A. Clean or replace filter.

Q. Have ignition parts failed?

A. Have serviced by a Yamaha dealer.

Q. Has alert system activated?

A. Find and correct cause of alert.

Q. Is spark plug gap incorrect?

A. Inspect and adjust as specified.

Q. Is ignition wiring damaged or poorly connected?

A. Check wires for wear or breaks. Tighten all loose connections. Replace worn or broken wires.

Q. Is specified engine oil not being used?

A. Check and replace oil as specified.

Q. Is thermostat faulty or clogged?

A. Have serviced by a Yamaha dealer.

Q. Are carburetor adjustments incorrect?

A. Have serviced by a Yamaha dealer.

Q. Is fuel pump damaged?

A. Have serviced by a Yamaha dealer.

Q. Is air vent screw on fuel tank closed?

A. Open air vent screw.

Q. Is choke knob pulled out?

A. Return to home position.

Q. Is motor angle too high?

A. Return to normal operating position.

Q. Is carburetor clogged?

A. Have serviced by a Yamaha dealer.

Q. Is fuel joint connection incorrect?

A. Connect correctly.

Q. Is throttle valve adjustment incorrect?

A. Have serviced by a Yamaha dealer.

Q. Is battery cable disconnected?

A. Connect securely.

## **Alert buzzer sounds or indicator lights.**

Q. Is cooling system clogged?

A. Check water intake for restriction.

Q. Is engine oil level low?

A. Fill oil tank with specified engine oil.

Q. Is heat range of spark plug incorrect?

A. Inspect spark plug and replace it with recommended type.

Q. Is specified engine oil not being used?

A. Check and replace oil with specified type.

Q. Is engine oil contaminated or deteriorated?

A. Replace oil with fresh, specified type.

Q. Is oil filter clogged?

A. Have serviced by a Yamaha dealer.

Q. Has oil feed/injection pump malfunctioned?

A. Have serviced by a Yamaha dealer.

# Trouble Recovery

---

Q. Is load on boat improperly distributed?

A. Distribute load to place boat on an even plane.

Q. Is water pump or thermostat faulty?

A. Have serviced by a Yamaha dealer.

Q. Is there excess water in fuel filter cup?

A. Drain filter cup.

## Engine power loss.

Q. Is propeller damaged?

A. Have propeller repaired or replaced.

Q. Is propeller pitch or diameter incorrect?

A. Install correct propeller to operate outboard at its recommended speed (r/min) range.

Q. Is trim angle incorrect?

A. Adjust trim angle to achieve most efficient operation.

Q. Is motor mounted at incorrect height on transom?

A. Have motor adjusted to proper transom height.

Q. Has alert system activated?

A. Find and correct cause of alert.

Q. Is boat bottom fouled with marine growth?

A. Clean boat bottom.

Q. Are spark plug(s) fouled or of incorrect type?

A. Inspect spark plug(s). Clean or replace with recommended type.

Q. Are weeds or other foreign matter tangled on gear housing?

A. Remove foreign matter and clean lower unit.

Q. Is fuel system obstructed?

A. Check for pinched or kinked fuel line or other obstructions in fuel system.

Q. Is fuel filter clogged?

A. Clean or replace filter.

Q. Is fuel contaminated or stale?

A. Fill tank with clean, fresh fuel.

Q. Is spark plug gap incorrect?

A. Inspect and adjust as specified.

Q. Is ignition wiring damaged or poorly connected?

A. Check wires for wear or breaks. Tighten all loose connections. Replace worn or broken wires.

Q. Have electrical parts failed?

A. Have serviced by a Yamaha dealer.

Q. Is specified fuel not being used?

A. Replace fuel with specified type.

Q. Is specified engine oil not being used?

A. Check and replace oil with specified type.

Q. Is thermostat faulty or clogged?

A. Have serviced by a Yamaha dealer.

Q. Is air vent screw closed?

A. Open the air vent screw.

Q. Is fuel pump damaged?

A. Have serviced by a Yamaha dealer.

Q. Is fuel joint connection incorrect?

# Trouble Recovery

---

A. Connect correctly.

Q. Is heat range of spark plug incorrect?

A. Inspect spark plug and replace it with recommended type.

Q. Is high pressure fuel pump drive belt broken?

A. Have serviced by a Yamaha dealer.

Q. Is engine not responding properly to shift lever position?

A. Have serviced by a Yamaha dealer.

## Engine vibrates excessively.

Q. Is propeller damaged?

A. Have propeller repaired or replaced.

Q. Is propeller shaft damaged?

A. Have serviced by a Yamaha dealer.

Q. Are weeds or other foreign matter tangled on propeller?

A. Remove and clean propeller.

Q. Is motor mounting bolt loose?

A. Tighten bolt.

Q. Is steering pivot loose or damaged?

A. Tighten or have serviced by a Yamaha dealer.

EMU29433

## Temporary action in emergency

EMU29440

### Impact damage

EWM00870

#### **WARNING**

The outboard motor can be seriously damaged by a collision while operating or trailering. Damage could make the outboard motor unsafe to operate.

---

If the outboard motor hits an object in the water, follow the procedure below.

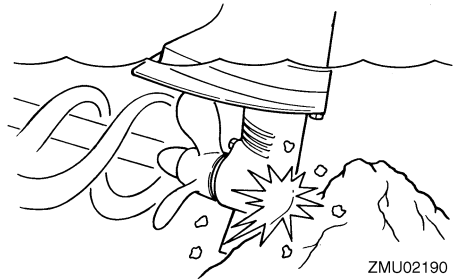

1. Stop the engine immediately.
2. Inspect the control system and all components for damage. Also inspect the boat for damage.
3. Whether damage is found or not, return to the nearest harbor slowly and carefully.
4. Have a Yamaha dealer inspect the outboard motor before operating it again.

EMU34870

## Starter will not operate

If the starter mechanism does not operate (the engine cannot be cranked with the starter), the engine can be started with an emergency starter rope.

EWM01740

#### **WARNING**

- Use this procedure only in an emergency to return to the nearest port for repairs.
- Make sure the gear shift lever is in neutral. Otherwise the boat could unexpectedly start to move, which could result in an accident.
- Make sure no one is standing behind you when pulling the starter rope. It could whip behind you and injure someone.

# Trouble Recovery

- An unguarded, rotating flywheel is very dangerous. Keep loose clothing and other objects away when starting the engine. Use the emergency starter rope only as instructed. Do not touch the flywheel or other moving parts when the engine is running. Do not install the starter mechanism or top cowling after the engine is running.
- Do not touch the ignition coil, spark plug wire, spark plug cap, or other electrical components when starting or operating the motor. You could get an electrical shock.

6. Give a strong pull straight out to crank and start the engine. Repeat if necessary.

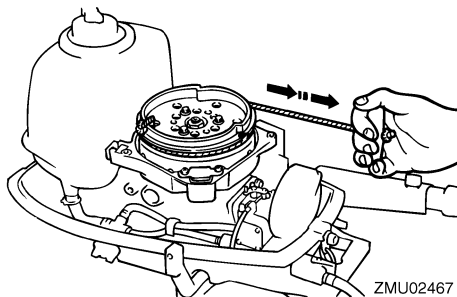

EMU34880

## Emergency starting engine

1. Remove the top cowling.
2. Remove the starter after removing the bolt(s).

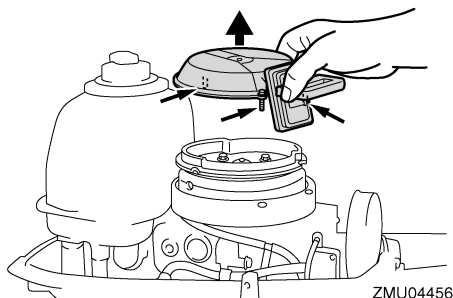

3. Prepare the engine for starting. For further information, see page 23. Be sure the gear shift lever is in neutral.
4. Pull out the choke knob when the engine is cold. After the engine starts, gradually return the choke knob to its home position as the engine warms up.
5. Insert the knotted end of the emergency starter rope into the notch in the flywheel rotor and wind the rope several turns around the flywheel clockwise.

EMU33501

## Treatment of submerged motor

If the outboard motor is submerged, immediately take it to a Yamaha dealer. Otherwise some corrosion may begin almost immediately. **NOTICE: Do not attempt to run the outboard motor until it has been completely inspected.** [ECM00401]



**YAMAHA**

YAMAHA MOTOR CO., LTD.

Printed in Japan

March 2008-0.4 × 1 CR

Printed on recycled paper